



Becoming a
MotorScrubber
**US Stocking
Partner**

2021 Price List



The Ultimate Deep Cleaning & Virus Control System.

3 Incredible Products. 1 Immense System.

Transform cleaning by making it faster and safer, whilst achieving outstanding hygiene results on all floors and surfaces, with the DMT System + Virus Control.

Deep Clean

Use JET3 to scrub floors, walls and stairs.

Maintain

Use BLADE to maintain deep cleaned floors.

Transform

Outstanding hygiene achieved on all floors.

+ Virus Control

Use STORM® to disinfect common touch points, and transform all surfaces.



Grab. Clean. Dock

Hangs the DMT system neatly on the wall.

Wall Dock mounts the DMT System + Virus Control to the wall for easy storage.



DMT System - Buy products separately and bundle for your customers needs.

Description	Code
The DMT System with Virus Control (Includes JET3, BLADE, STORM® and Wall Dock)	--
JET3 Kit	MSJET3
STORM® - wand only (connects to JET3 backpack)	MSSTORM
BLADE (As shown, with Frame, injection handle and 1 S-Fibre)	
Wall Dock	MS1073

Prices and discounts shown may differ depending on quantities ordered.

In-store Display Unit

Show off the JET3 and M3 machines with our eye-catching in-store display.

The display holds:

- 1 x JET3**
- 1 x M3**
- 1 x Battery Powered Backpack**
- 5 x brushes, up to 9 pads**
- A4 literature**
- 22" TV.**

The display comes flat packed and the foldable steel is super easy to assemble, perfect for your showroom or at exhibitions.

FREE DISPLAY
WITH YOUR FIRST ORDER OF 14 MACHINES



WHAT'S INCLUDED?

Main display (2 parts), 22" TV, leaflet holder, USB with videos, all fixtures and fittings.

Packed dimensions:
L 120 x W 100 x H 10cm

Assembled dimensions:
W 130 x H 206.5 x D 44cm
(inc. machine. 23cm Deep - display only)

PRICING

EXTRAS

Want the display to include accessories and machines as shown? Purchase the M-Case Pro, that includes everything shown and can be used for transporting products to demonstrations.

(Turn to page 28 to see full list of items included)

TO PLACE AN ORDER

usaorders@motorscrubberclean.com
630 326 3107



New Style Backpack
Coming 3rd
Quarter 2021
Page 35

- 1. J2 Handle Complete
- 2. J1 Backpack Complete
- 3. J3 Motor Head Complete
- 4. MS1041 Medium Duty Brush
- 5. MS1053 8 inch Microfibre Pad
- 6. MS1066 8 inch White Pad
- 7. MS1062 8 Inch Green Pad
- 8. MS1064 8 inch Red Pad
- 9. MS1046 Pad Holder
- 10. MS1580 Battery Charger



Description	Code
JET3 Kit	MSJET3
JET3 (No backpack) includes medium brush, pad holder, micropad, 3 pads, no charger	MSJET3NOBACKPACK
Sold as upgrade if someone has bought STORM®	

Box and pallet information

JET3

Single Box
Weight - 18.74lbs

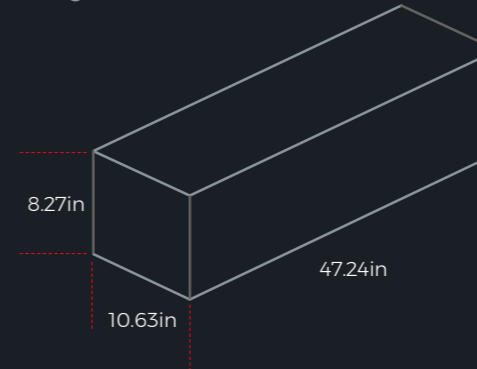

Pallet = 36 machines
Weight - 660.96lbs

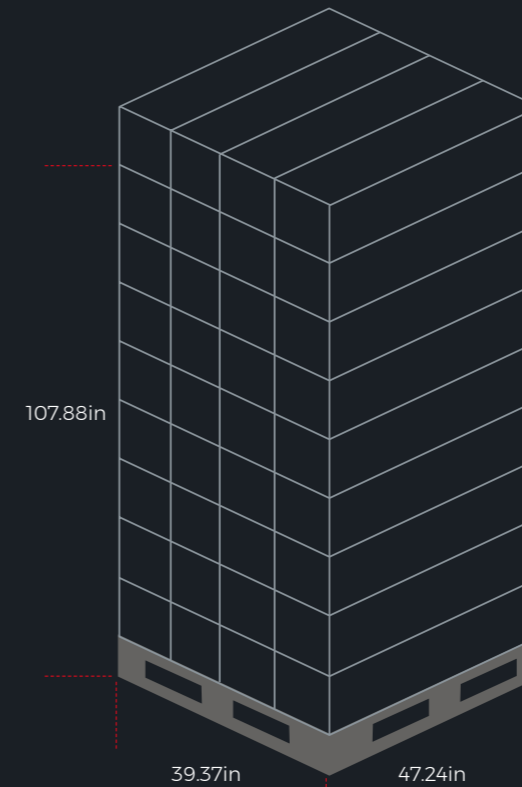



New Style Backpack
Coming 3rd Quarter 2021
Page 35



1. MSSTORM STORM® Wand
2. J1 Back Pack Complete
3. MSS31 M-Wipes Kit. (1 roll of M-Wipes, Dispenser and Disposal Pouches)
4. MST5B Foldable Bottle Carrier for extra capacity. x8 slots. (Holds Solution Bottles and M-Wipes)

Description	Code
STORM® wand with backpack	MSSTORMCOMP
STORM® - wand only (connects to JET3 backpack)	MSSTORM
68 micron jet nozzle	MSS25
Jet Cap	MST1
12 Volt Battery	12V7A
3 Core Coiled Cable with Female Metal Quick Fit Connector	MSJ01
US Charger	MS1580US
M-Wipes Kit (1 box of M-Wipes, dispenser & disposal pouch)	MSS31
1 box of M-Wipes (6 rolls of 100 wipes)	MSS30
M-Wipe Dispenser Pouch	MSJ62
M-Wipe Disposal Pouch	MSJ61
Bottle Carrier (holds 8 bottles)	MST5B
Bottles	MSJ09B
Bottle Cap	MSJ10B

Box and pallet information

STORM® with Backpack

Single Box
Weight - 10.5lbs

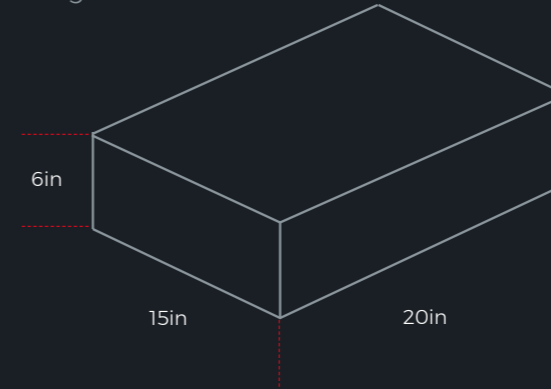

STORM® wand only

Single Box
Weight - 0.6lbs

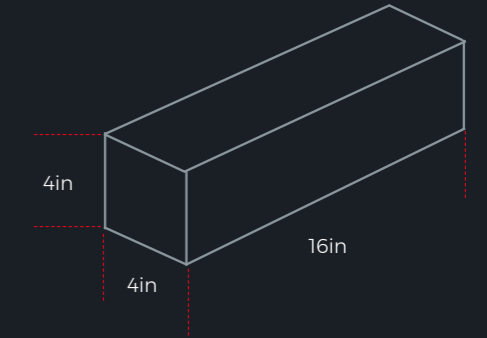

STORM® with Backpack

Pallet = 84 machines
Weight - 888.4lbs

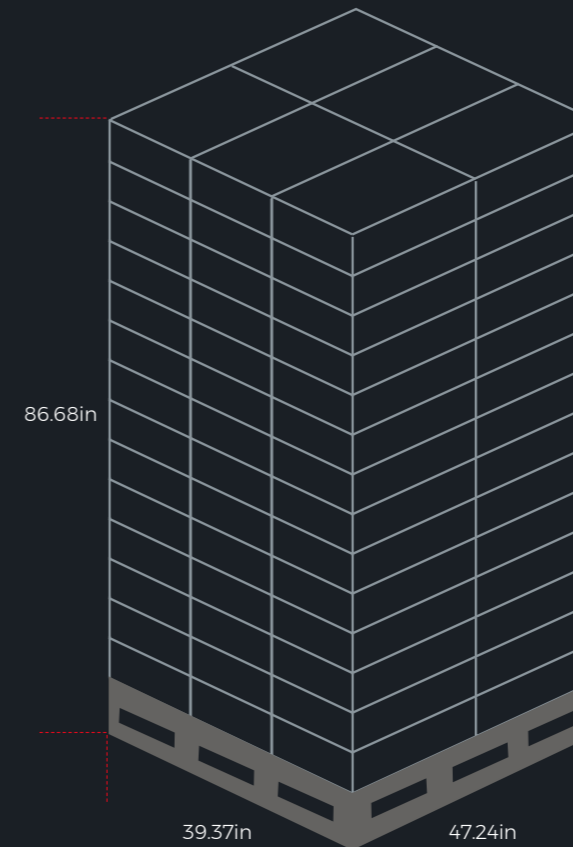



- 1. **MSBLADEIH** Injection Handle
- 2. **MSBLADEF** BLADE Frame
- 3. **MSBLADER** BLADE Rubber Refill
- 4. **S-FIBRE** S-FIBRE (Scrub)
- 5. **G-FIBRE** G-FIBRE (Glide)
- 6. **A-FIBRE** A-FIBRE (Absorb)

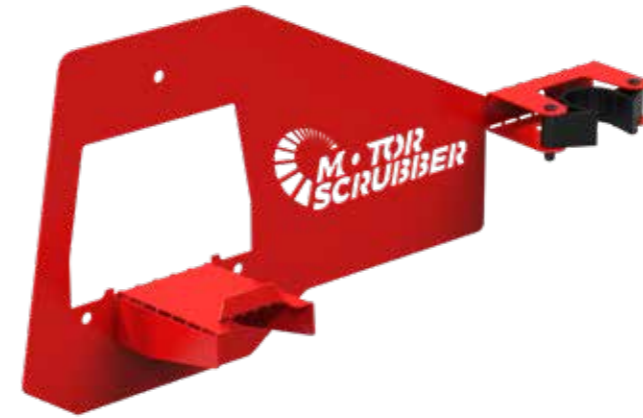

MotorScrubber® Wall Dock

Hang your system neatly on the wall.

Used in conjunction with the MotorScrubber JET and BLADE, as part of the DMT system.



Description	Min. Order Qty	Code
BLADE Frame	Box of 5 Case of 40 available	MSBLADEF
BLADE Fluid Injection handle	Case of 25	MSBLADEIH
BLADE Rubber Refill	--	MSBLADER
S-FIBRE (Scrub) Pack of 5	Pack of 5 Case of 20 packs of 5 available	S-FIBRE-5
G-FIBRE (Daily Clean) Pack of 5	Pack of 5 Case of 32 packs of 5 available	G-FIBRE-5
A-FIBRE (Absorb 500ml) Pack of 5	Pack of 5 Case of 20 packs of 5 available	A-FIBRE-5

Description	Code
Wall Dock	MS1073



- 1. MS3004B Grab Handle
- 2. MS3114C Backpack Complete
- 3. MSGREY12V Motor Housing with Y Shaped Connection
- 4. MS7003 Hub - Rotating Disc
- 5. MS1041 Medium Duty Brush
- 6. MS1053 8 inch Microfibre Pad
- 7. MS1066 8 inch White Pad
- 8. MS1062 8 Inch Green Pad
- 9. MS1064 8 inch Red Pad
- 10. MS1046 Pad Holder
- 11. MS1580 Battery Charger
- 12. MS4005 Universal Screw Pack



Description Code

Starter Kit Long Handle
Telescopic 120cm - 240cm

Recommended for regular high level wall cleaning, occasional floor cleaning.

M3L

Starter Kit Medium Handle
Telescopic 70cm - 140cm

Recommended for regular floor cleaning, occasional wall cleaning.

M3M

Bestseller

Starter Kit Short Handle
Solid 38cm

Recommended eye level cleaning.

M3S

Box and pallet information

M3S & M3M

Single Box
Weight - 17.6lbs

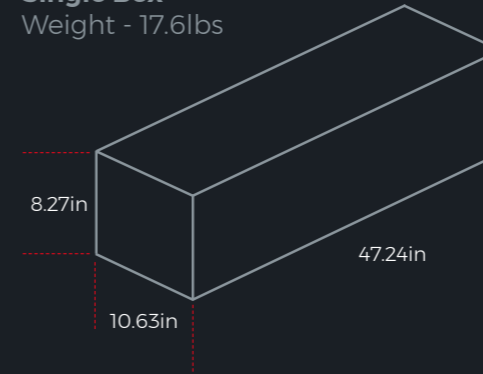

M3L

Single Box
Weight - 17.6lbs

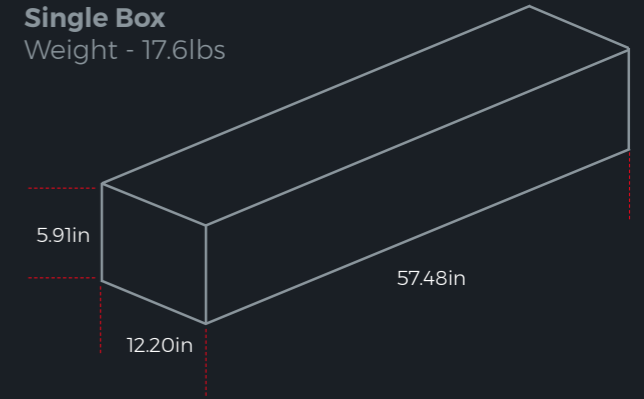

M3S & M3M

Pallet = 36 machines
Weight - 657lbs

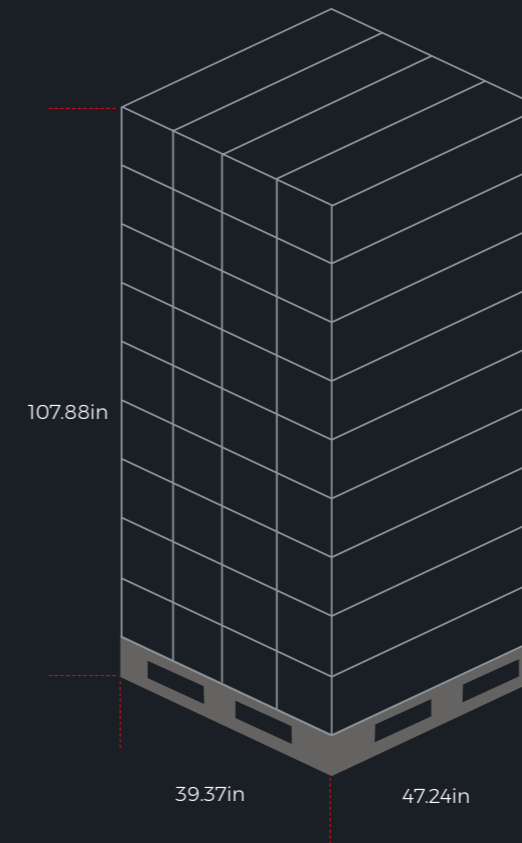

M3L

Pallet = 36 machines
Weight - 657lbs

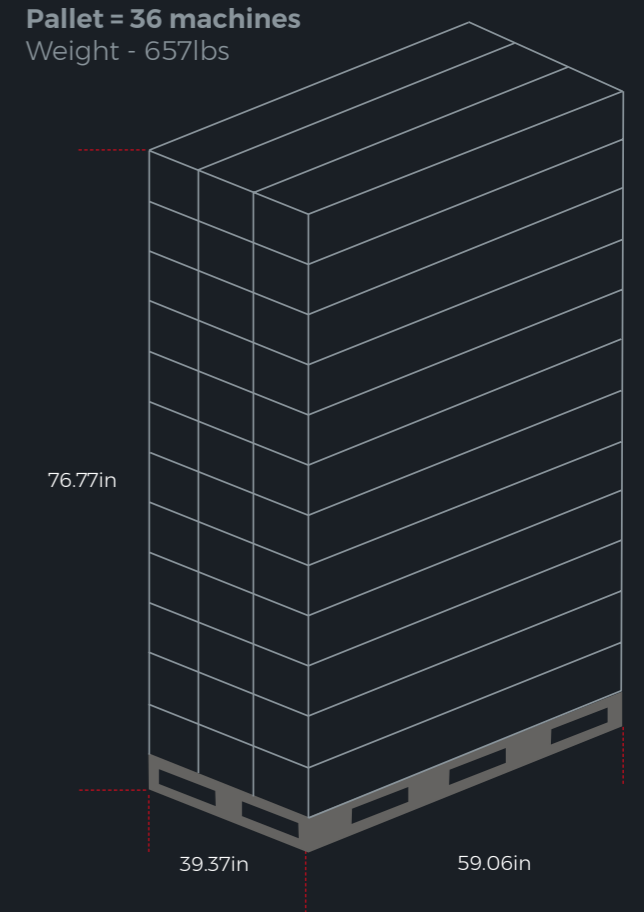

FORCE

- 1. 15 amp fused battery connector
- 2. Universal hose adapter
- 3. 24 Volt Commercial grade pump with 1 Metre water pipe and inline filter.



Description	Code
FORCE Kit 24 Volt	MSFORCE

FORCE is designed to fit any large scrubber dryer

Brackets are needed to fix FORCE to large scrubber dryer - Ask for Full FORCE price list



Box and pallet information

FORCE

Single Box
Weight - 24.25lbs

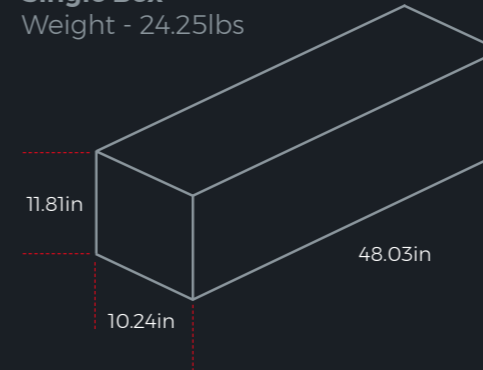

Pallet = 24 machines
Weight - 604.7lbs

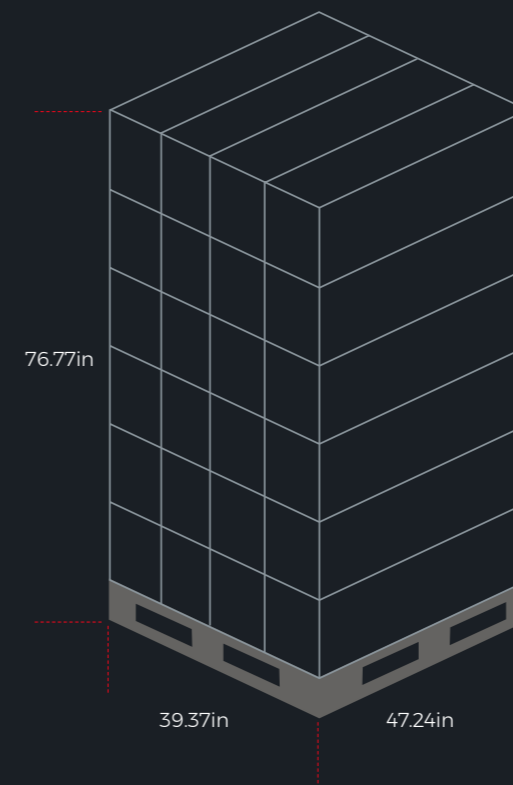

1. MSPROWASH2 Long Handle
(4 metre reach) with Backpack
2. MS1044 Long Bristle Brush
3. MSPROWASH Steel Cart Complete
4. MS1066 White Pad
5. MS1062 Green Pad
6. MS1068 Blue Pad
7. MS1046 Pad Holder

New Style Backpack
Coming 3rd
Quarter 2021
Page 35



Box and pallet information

PROWASH

Single Box
Weight - 127.87lbs

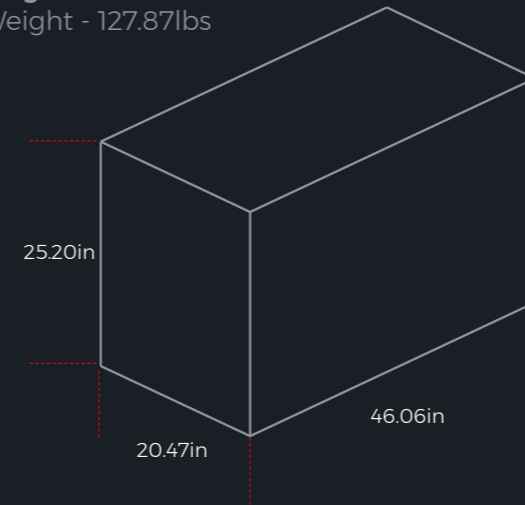

Pallet = 4 machines
Weight - 533.52lbs

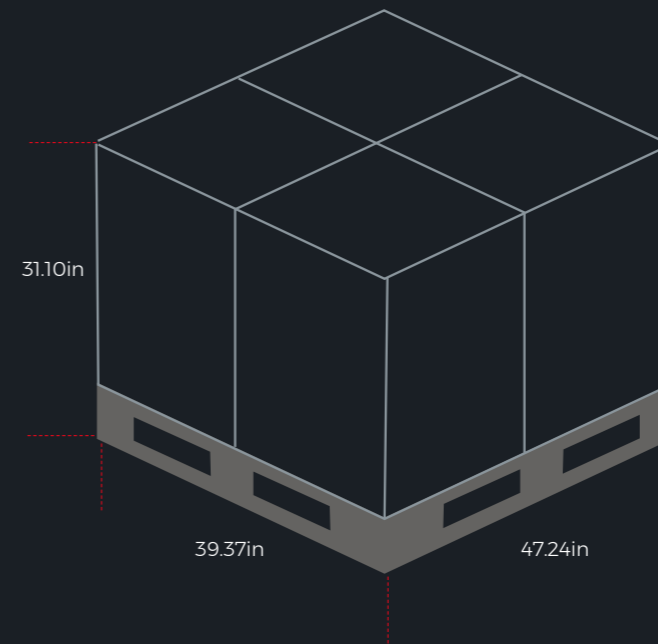

Description	Code
PROWASH Kit Trolley with Long Handle Motorscrubber	MSPROWASH
Short Handle	MSPROA3S
Trolley Only	MSPROTROLLEY

Also available to order

• Short handle • Glass fibre pole • 6 metre pole • Carbon pole

Handle support for PROWASH available.
Ask for more information.



HANDY Kit

- a. Fast battery charger
- b. Battery
- c. Cone shaped crevice brush
- d. Round scrubbing brush
- e. Handy machine
- f. Grout cleaning brush
- g. Velcro pad holder
- h. Deep cleaning pad

OPTIONAL

- 1. Stainless steel brush kit
- 2. Soft polishing kit



- 1. Suction housing
- 2. Universal hose adapter
- 3. 5 metre hose
- 4. 2 hose clamps
- 5. 2 quick fit squeegees



Description	Code
HANDY Kit	MSHANDY
Stainless Steel brush kit	MSHSS
Soft polishing kit	MSHSB
Deep Cleaning pads (10 pack)	MSHMR10
Extra battery	MSHBAT

Description	Code
Suction Kit	MSF61

SUCTION KIT is designed to fit both JET3 and M3 machines.





Optional Extras



- MS3070** M-Case Pro
- Case only

- M-Case Pro Complete
- 1. MS3070** M-Case
- 2. MSJET3DK** JET3 Complete (includes Backpack)
- 3. MSBLADEIH** Blade Injection Handle
- 4. MSBLADEF** Blade Frame
- 5. MSSTORM** STORM® Wand Only
- 6. MSS31** M-Wipes Kit
- 7. MS1049** Red Stair Brush
- 8. MS1039TG** Tile & Grout Brush
- 9. MS1044** Flagged Tipped Brush
- 10. MS1039P** Aggressive Duty Brush
- 11. MS1038** Delicate Brush
- 12. MS1069S** Maroon Pad x2
- 13. MS1070S** Melamine Pad x2
- 14. S-FIBRE-1** S-Fibre x2
- 15. A-FIBRE-1** A-Fibre x2
- 16. G-FIBRE-1** G-Fibre x2







- 17. MSJETMASK** JET3 with Suction Kit
- 18. 211760S** Yellow Twister Pad
- 19. 211763S** White Twister Pad
- 20. 211759S** Green Twister Pad















Description	Code
M-CASE PRO (Case only)	MS3070
M-CASE PRO (JET3, BLADE, STORM® and all accessories)	MS3070KIT
M-CASE PRO (JET3, BLADE, STORM®, 1x JET3 with suction kit and all accessories)	MS3070KIT+





Brushes and Pads



Description		Code
	Delicate Cleaning Brush	MS1038
	Aggressive Duty Brush	MS1039P
	Tile and Grout Brush	MS1039TG
	Medium Duty Brush	MS1041
	Flagged Tipped Brush	MS1044
	Stair Brush	MS1049
	Grit Stair Brush	MS1049T

Description		Code
	Pad Holder (Drive Plate) x1	MS1046
	22cm Microfibre Multi Purpose Cleaning Pad x1	MS1053
	Melamine Pad x5	MS1070
	20cm Black Stripping Pad x5	MS1060
	20cm Green Scrubbing Pad x5	MS1062
	20cm Red Spray Cleaning Pad x5	MS1064
	20cm Blue Cleaning Pad x5	MS1068
	20cm White Dry Buffing Pad x5	MS1066
	20cm High Performance Stripping Pad x10	MS1069
	Crystalliser Pad x2	MS1071
	20cm White Twister Pad - Refurbishing x2	211763
	20cm Yellow Twister Pad - Shine Creating x2	211760
	20cm Green Twister Pad - Shine & Maintain x2	211759

Accessories and Chemicals

Description		Code
 Handle 125cm Telescopic		MS4003L
 Handle 75cm Telescopic		MS4003M
 Handle 38cm Hand Held Solid		MS4003S
 Splash Guard Kit		MS3080
 Crystalliser Chemical (1 bottle = 0.22gl)		MS1072

M-CASE

M-Case holds:

- 1 x Backpack
- 1 x Machine
- 4 x Accessories



Description	Code
M-Case	MS3061

Coming 3rd Quarter 2021

Generation 3 Power Pack.

Powered by MotorScrubber Battery Backpack Technology.

DUAL
P-POWER
1 BACKPACK. 2 MACHINES.



Universal Belt Design
NEW! Improved belt design. Fully Adjustable (fits any user). Simply overlap the velcro belt straps until a secure fit is achieved.



Fatigue Free Use
Backpack secured to the waist, maintaining perfect posture.









All Day Comfort
Adjustable shoulder straps offer comfort and support to the operator.



Recommended spares to stock

For a full spares list please email orders@motorscrubberclean.com or call +44 (0)114 478 8710















Description	Code
 Battery and Harness Complete With Coiled Cable (Excluding Charger)	MS3114C
 Motor Housing with Y Shaped Connection	MSGREY12V
 Hardware Packet (Contains all screws)	MS4005
 Battery Coiled Cable 110cm	MS3009
 US Charger	MS1580US
 On / Off Switch	MSS11

OTHER PARTS (Not recommended to stock)

Description	Code
 12 Volt Battery	12V7A
 Rubber Grip	MSS103
 Complete Switch Housing	MSS402







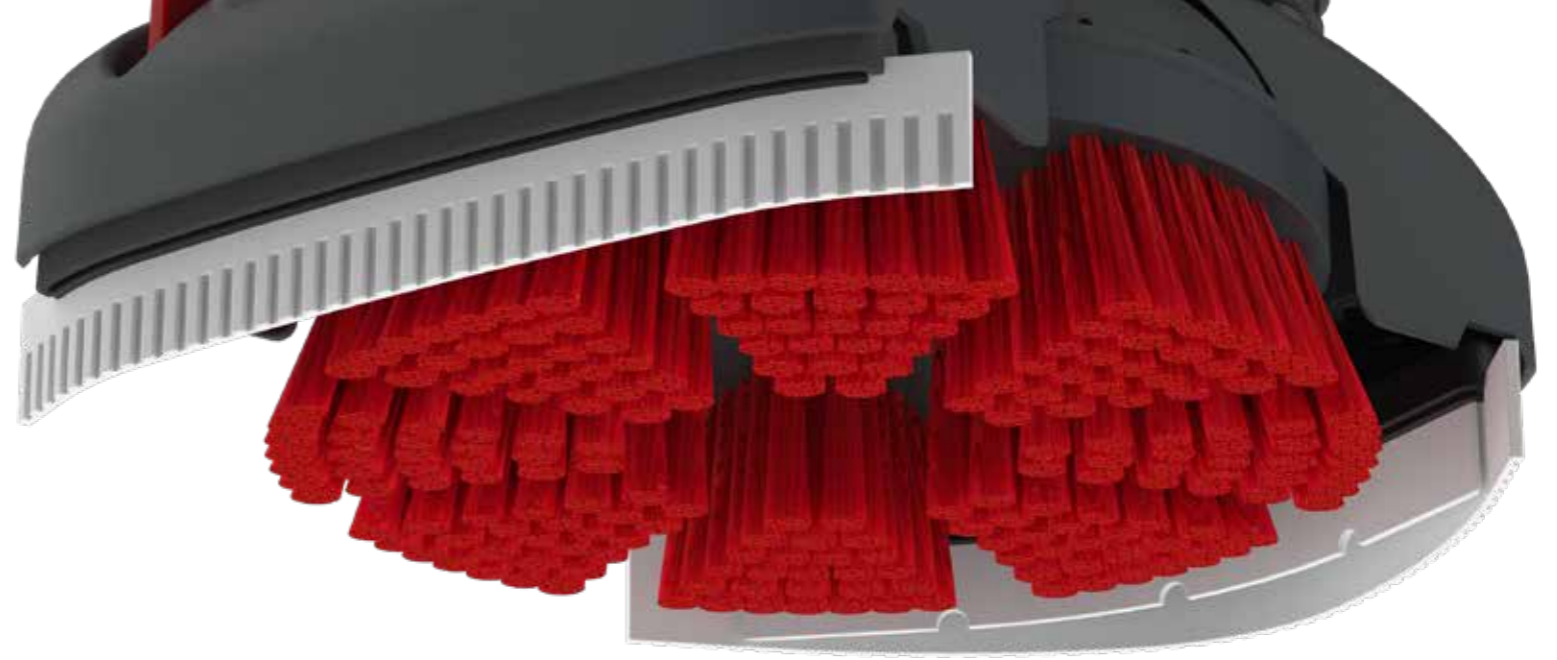













Description	Code
 Motor Housing with Y Shaped Connection	MSGREY12V
 Rubber Grip	MSS103
 3 Core Coiled Cable with Female Metal Quick Fit Connector	MSJ01
 3 Core Straight Cable with Male Metal Quick Fit Connector	MSJ03B
 Jet Pump	MSJ06
 Bottle	MSJ09B
 Bottle cap	MSJ10B
 4mm Push Fit Check Valve x1	MSJ11
 Hose End Filter	MSJ15B
 On / Off Switch	MSS11
 Blue Demand Pump Switch	MSJ26
 US Charger	MS1580US

Recommended spares to stock



FORCE











Description	Code
 Motorhead 24V Motor - Light Grey	MSGREY24V
 FORCE Suction Housing	MSF14
 Stainless jet FORCE	MSF15B
 Squeegee Set - Front & Back	MSF13
 Medium Duty Brush	MS1041
 On / Off Switch	MSS11
 Blue Demand Pump Switch	MSJ26
 FORCE Cable	MSF10
 Rubber Grip	MSS103
 Hose Universal Connector	MSF6

Description	Code
 FORCE Hose 8 Metre	MSF7
 24V Pump with Terminated Cables	MSF11
 Inline Water Filter	MSJ15C
 Check Valve (single)	MSJ11
 Horn Hose Wind (single)	MSF1
 Lower FORCE Mount Complete	MSF2
 Upper FORCE Bracket with Hose Clamp	MSF3
 2 Way 24V DC Switch for Vacuum Motor	MSF18
 T Connector to fit 10mm ID Water Pipe	MSF19







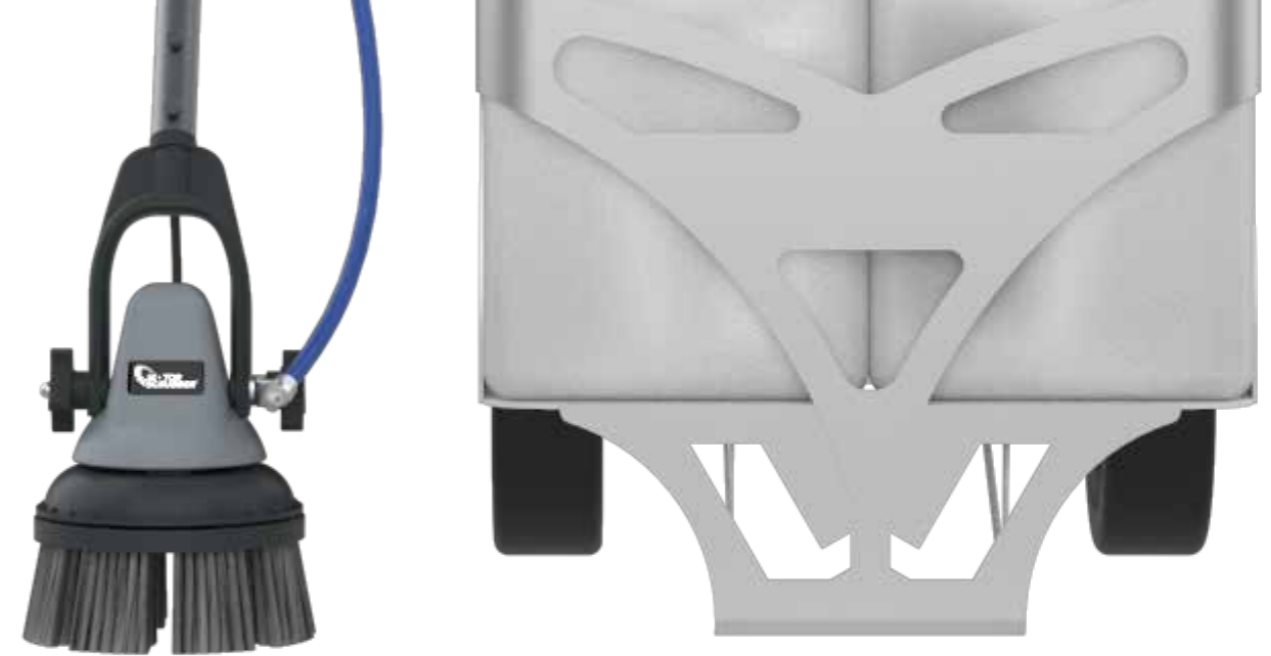

Ask for the full **FORCE price list** and **One Drive technical link**, for the brackets that fit all brands.

Recommended spares to stock



Description	Code
 R Clip For Wheels	MSPRO4
 PROWASH Pump	MSPRO5
 PROWASH Battery 12 Volt 22Ah	MSPRO6
 PROWASH Charger US	MSPRO7-USA
 Chemical Dosing Tap	MSPRO8
 Battery Level Indicator	MSPRO10
 ON / OFF Switch	MSPRO11
 25 Litre Bottle with Cap	MSPRO12
 Water Bottle Weighted Filter	MSPRO14
 25 Metre 5mm Hose	MSPRO16



Description	Code
 Pump Inlet Fitting 3/8 BSP 8mm 90 Degree	MSPRO20
 Hose Reel Female Quick Coupler with Barb Hose Tail	MSPRO24
 Sealey Single Ear O Clip 9.8 - 11.8mm	MSPRO25
 8mm OD Blue Polyurethane Tube for Push Fit Fittings 1 Metre	MSPRO40
 10mm OD Clear Chemical Tube 60cm	MSPRO41
 Trigger Assembly	MSPRO50
 Trigger Bracket	MSPRO51
 2.5 Metre Microbore Hose Blue (For Long Handle Machine)	MSPRO54
 Double Bottle Assembly with Pipework, Filters and Quick Connector (Quick Change Bottles Complete)	MSPRO70